

Description

The DigiFlex® Performance™ (DP) Series digital servo drives are designed to drive brushed and brushless servomotors. These fully digital drives operate in torque, velocity, or position mode and employ Space Vector Modulation (SVM), which results in higher bus voltage utilization and reduced heat dissipation compared to traditional PWM. The drive can be configured for a variety of external command signals. Commands can also be configured using the drive's built-in Motion Engine, an internal motion controller used with distributed motion applications. In addition to motor control, these drives feature dedicated and programmable digital and analog inputs and outputs to enhance interfacing with external controllers and devices.

This DP Series drive features a CANopen interface for networking and a RS-232 interface for drive configuration and setup. Drive commissioning is accomplished using DriveWare® 7, available for download at www.a-m-c.com.

All drive and motor parameters are stored in non-volatile memory.

Power Range

Peak Current	15 A (10.6 A _{RMS})
Continuous Current	7.5 A (7.5 A _{RMS})
Supply Voltage	100 - 240 VAC



Features

- ▲ Four Quadrant Regenerative Operation
- ▲ Space Vector Modulation (SVM) Technology
- ▲ Fully Digital State-of-the-art Design
- ▲ Programmable Gain Settings
- ▲ Fully Configurable Current, Voltage, Velocity and Position Limits
- ▲ PIDF Velocity Loop
- ▲ PID + FF Position Loop
- ▲ Compact Size, High Power Density
- ▲ 16-bit Analog to Digital Hardware
- ▲ On-the-Fly Mode Switching
- ▲ On-the-Fly Gain Set Switching

MODES OF OPERATION

- Profile Current
- Profile Velocity
- Profile Position
- Cyclic Synchronous Current Mode
- Cyclic Synchronous Velocity Mode
- Cyclic Synchronous Position Mode

COMMAND SOURCE

- ±10 V Analog
- PWM and Direction
- Encoder Following
- Over the Network
- Sequencing
- Indexing
- Jogging

FEEDBACK SUPPORTED

- ±10 VDC Position
- Resolver
- Auxiliary Incremental Encoder
- Tachometer (±10 VDC)

INPUTS/OUTPUTS

- 3 High Speed Captures
- 4 Programmable Analog Inputs (16-bit/12-bit Resolution)
- 1 Programmable Analog Output (10-bit Resolution)
- 3 Programmable Digital Inputs (Differential)
- 7 Programmable Digital Inputs (Single-Ended)
- 4 Programmable Digital Outputs (Single-Ended)

COMPLIANCES & AGENCY APPROVALS

- UL
- cUL
- CE Class A (LVD)
- CE Class A (EMC)
- RoHS

BLOCK DIAGRAM

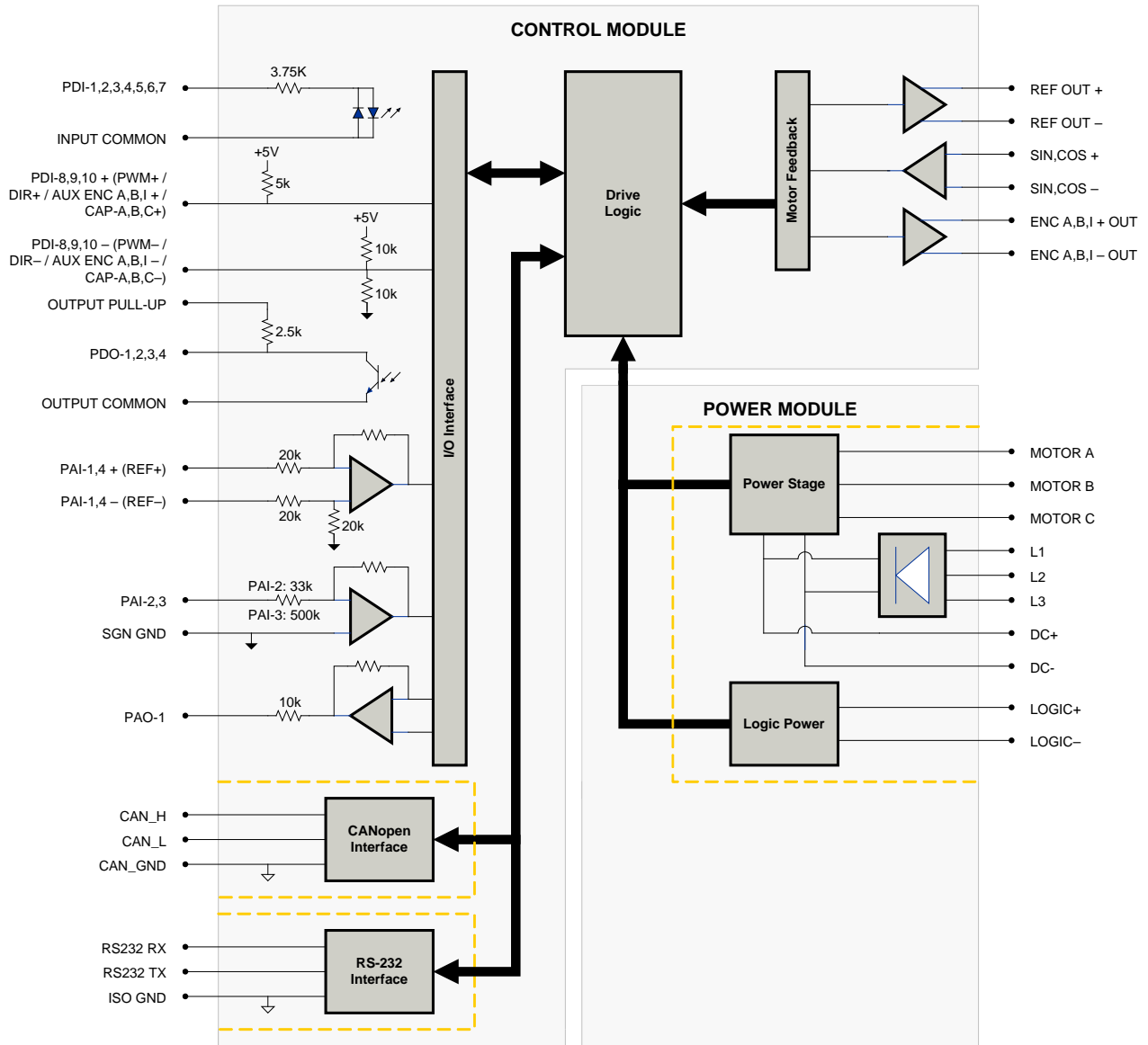

Information on Approvals and Compliances



US and Canadian safety compliance with UL 508c, the industrial standard for power conversion electronics. UL registered under file number E140173. Note that machine components compliant with UL are considered UL registered as opposed to UL listed as would be the case for commercial products.



Compliant with European CE for both the Class A EMC Directive 2004/108/EC on Electromagnetic Compatibility (specifically EN 61000-6-4:2007 and EN 61000-6-2:2005) and LVD requirements of directive 2006/95/EC (specifically EN 60204-1:2006), a low voltage directive to protect users from electrical shock.



RoHS (Reduction of Hazardous Substances) is intended to prevent hazardous substances such as lead from being manufactured in electrical and electronic equipment.

SPECIFICATIONS

Power Specifications			
Description	Units	Value	
Rated Voltage	VAC (VDC)	240 (339)	
AC Supply Voltage Range	VAC	100 - 240	
AC Supply Minimum	VAC	90	
AC Supply Maximum	VAC	264	
AC Input Phases ¹	-	3	
AC Supply Frequency	Hz	50 - 60	
DC Supply Voltage Range ²	VDC	127 - 373	
DC Bus Over Voltage Limit	VDC	394	
DC Bus Under Voltage Limit	VDC	55	
Logic Supply Voltage	VDC	20 - 30 (@ 850 mA)	
Maximum Peak Output Current ³	A (Arms)	15 (10.6)	
Maximum Continuous Output Current ⁴	A (Arms)	7.5 (7.5)	
Max. Continuous Output Power @ Rated Voltage ⁵	W	2415	
Max. Continuous Power Dissipation @ Rated Voltage	W	127	
Internal Bus Capacitance	µF	660	
Minimum Load Inductance (Line-To-Line) ⁶	µH	600	
Switching Frequency	kHz	20	
Maximum Output PWM Duty Cycle	%	100	
Low Voltage Supply Outputs	-	+5 VDC (250 mA)	
Control Specifications			
Description	Units	Value	
Communication Interfaces	-	CANopen (RS-232 for configuration)	
Command Sources	-	±10 V Analog, Encoder Following, Over the Network, PWM and Direction, Sequencing, Indexing, Jogging	
Feedback Supported	-	±10 VDC Position, Auxiliary Incremental Encoder, Resolver, Tachometer (±10 VDC)	
Commutation Methods	-	Sinusoidal	
Modes of Operation	-	Profile Current, Profile Velocity, Profile Position, Cyclic Synchronous Current Mode, Cyclic Synchronous Velocity Mode, Cyclic Synchronous Position Mode	
Motors Supported	-	Closed Loop Vector, Single Phase (Brushed, Voice Coil, Inductive Load), Three Phase (Brushless)	
Hardware Protection	-	40+ Configurable Functions, Over Current, Over Temperature (Drive & Motor), Over Voltage, Short Circuit (Phase-Phase & Phase-Ground), Under Voltage	
Programmable Digital Inputs/Outputs (PDIs/PDOs)	-	10/4	
Programmable Analog Inputs/Outputs (PAIs/PAOs)	-	4/1	
Primary I/O Logic Level	-	24 VDC	
Current Loop Sample Time	µs	50	
Velocity Loop Sample Time	µs	100	
Position Loop Sample Time	µs	100	
Resolver Reference/Excitation Signal	Vrms	4 Vrms @ 5 kHz	
Expected Resolver Transformation Ratio	Vrms	0.5	
Feedback Resolution / Emulated Encoder Resolution ⁷	bit	High Res: 14 (16384 counts/resolver cycle), Low Res: 12 (4096 counts/resolver cycle)	
Maximum Motor Speed Per Feedback Resolution	RPM	High Res: 5000, Low Res: 20000	
Mechanical Specifications			
Description	Units	Value	
Agency Approvals	-	CE Class A (EMC), CE Class A (LVD), cUL, RoHS, UL	
Size (H x W x D)	mm (in)	177.5 x 139.7 x 55.9 (7 x 5.5 x 2.2)	
Weight	g (oz)	1273 (44.9)	
Heatsink (Base) Temperature Range ⁸	°C (°F)	0 - 65 (32 - 149)	
Storage Temperature Range	°C (°F)	-40 - 85 (-40 - 185)	
Form Factor	-	Panel Mount	
Cooling System	-	Natural Convection	
IP Rating	-	IP10	
+24V LOGIC Connector	-	2-port, 5.08 mm spaced, enclosed, friction lock header with threaded flange	
AUX COMM Connector	-	3-pin, 2.5 mm spaced, enclosed, friction lock header	
AUX ENCODER Connector	-	15-pin, high-density, male D-sub	
COMM Connector	-	Shielded, dual RJ-45 socket with LEDs	
FEEDBACK Connector	-	15-pin, high-density, female D-sub	
I/O Connector	-	26-pin, high-density, female D-sub	
POWER Connector	-	8-port, 7.62 mm spaced, enclosed, friction lock header	

Notes

- Can operate on single-phase VAC if peak/cont. current ratings are reduced by at least 30%.
- Large inrush current may occur upon initial DC supply connection to DC Bus.
- Capable of supplying drive rated peak current for 2 seconds with 10 second foldback to continuous value. Longer times are possible with lower current limits.
- Continuous I_{Arms} value attainable when RMS Charge-Based Limiting is used.
- (DC Rated Voltage) * (Cont. RMS Current) * 0.95.
- Lower inductance is acceptable for bus voltages well below maximum. Use external inductance to meet requirements.
- Higher and lower resolution options are available. Contact Applications Engineering for more information.
- Additional cooling and/or heatsink may be required to achieve rated performance.

PIN FUNCTIONS
+24V LOGIC - Logic Power Connector

Pin	Name	Description / Notes	I/O
1	LOGIC GND	Logic Supply Ground	GND
2	LOGIC PWR	Logic Supply Input	I

AUX COMM - RS232 Communication Connector

Pin	Name	Description / Notes	I/O
1	RS232 RX	Receive Line (RS-232)	I
2	RS232 TX	Transmit Line (RS-232)	O
3	ISO GND	Isolated Signal Ground	IGND

AUX ENCODER - Auxiliary Feedback Connector

Pin	Name	Description / Notes	I/O
1	RESERVED	Reserved	-
2	RESERVED	Reserved	-
3	RESERVED	Reserved	-
4	PDI-8 + (PWM+ / AUX ENC A+ / CAP-B+)	Programmable Digital Input or PWM or Auxiliary Encoder or High Speed Capture (For Single-Ended Signals Leave Negative Terminal Open)	I
5	PDI-8 - (PWM- / AUX ENC A- / CAP-B-)	Programmable Digital Input or PWM or Auxiliary Encoder or High Speed Capture (For Single-Ended Signals Leave Negative Terminal Open)	I
6	PDI-9 + (DIR+ / AUX ENC B+ / CAP-C+)	Programmable Digital Input or Direction Input or Auxiliary Encoder or High Speed Capture (For Single-Ended Signals Leave Negative Terminal Open)	I
7	PDI-9 - (DIR- / AUX ENC B- / CAP-C-)	Programmable Digital Input or Direction Input or Auxiliary Encoder or High Speed Capture (For Single-Ended Signals Leave Negative Terminal Open)	I
8	PDI-10 + (AUX ENC I+ / CAP-A+)	Programmable Digital Input or Auxiliary Encoder or High Speed Capture (For Single-Ended Signals Leave Negative Terminal Open)	I
9	PDI-10 - (AUX ENC I- / CAP-A-)	Programmable Digital Input or Auxiliary Encoder or High Speed Capture (For Single-Ended Signals Leave Negative Terminal Open)	I
10	SGN GND	Signal Ground	SGND
11	SGN GND	Signal Ground	SGND
12	SGN GND	Signal Ground	SGND
13	+5V OUT	+5V Encoder Supply Output (Short Circuit Protected)	O
14	PAI-4 +	Differential Programmable Analog Input (12-bit Resolution)	I
15	PAI-4 -		I

COMM - CAN Communication Connector

Pin	Name	Description / Notes	I/O
1	CAN_H	CAN_H Line (Dominant High)	I
2	CAN_L	CAN_L Line (Dominant Low)	I
3	CAN_GND	CAN Ground	CGND
4	RESERVED	Reserved	-
5	RESERVED	Reserved	-
6	RESERVED	Reserved	-
7	CAN_GND	CAN Ground	CGND
8	RESERVED	Reserved	-

FEEDBACK - Feedback Connector

Pin	Name	Description / Notes	I/O
1	RESERVED	Reserved	-
2	RESERVED	Reserved	-
3	RESERVED	Reserved	-
4	REF OUT +	Resolver Reference/Excitation Output	O
5	REF OUT -		O
6	SIN+	Resolver Sine Input	I
7	SIN-		I
8	COS+		Resolver Cosine Input
9	COS-	I	
10	RESERVED	Reserved	-
11	RESERVED	Reserved	-
12	SGN GND	Signal Ground	SGND
13	+5V OUT	+5V Encoder Supply Output (Short Circuit Protected)	O
14	PAI-3	Programmable Analog Input (12-bit Resolution)	I
15	RESERVED	Reserved	-

I/O - Signal Connector			
Pin	Name	Description / Notes	I/O
1	PDO-1	Isolated Programmable Digital Output	O
2	OUTPUT COMMON	Digital Output Common	OGND
3	PDO-2	Isolated Programmable Digital Output	O
4	PAI-1 + (REF+)	Differential Programmable Analog Input or Reference Signal Input (16-bit Resolution)	I
5	PAI-1 - (REF-)		I
6	PAI-2	Programmable Analog Input (12-bit Resolution)	I
7	PAO-1	Programmable Analog Output (10-bit Resolution)	O
8	OUTPUT PULL-UP	Digital Output Pull-Up For User Outputs	I
9	PDI-5	Isolated Programmable Digital Input	I
10	PDO-3	Isolated Programmable Digital Output	O
11	PDI-1	Isolated Programmable Digital Input	I
12	PDI-2	Isolated Programmable Digital Input	I
13	PDI-3	Isolated Programmable Digital Input	I
14	PDO-4	Isolated Programmable Digital Output	O
15	INPUT COMMON	Digital Input Common (Can Be Used To Pull-Up Digital Inputs)	IGND
16	SGN GND	Signal Ground	SGND
17	PDI-4	Isolated Programmable Digital Input	I
18	PDI-6	Isolated Programmable Digital Input	I
19	PDI-7	Isolated Programmable Digital Input	I
20	ENC A+ OUT	Emulated Encoder Channel A Output	O
21	ENC A- OUT		O
22	ENC B+ OUT	Emulated Encoder Channel B Output	O
23	ENC B- OUT		O
24	ENC I+ OUT	Emulated Encoder Index Output	O
25	ENC I- OUT		O
26	SGN GND	Signal Ground	SGND

POWER - Power Connector			
Pin	Name	Description / Notes	I/O
1	MOTOR A	Motor Phase A	O
2	MOTOR B	Motor Phase B	O
3	MOTOR C	Motor Phase C	O
4	DC+	Internal DC Bus Voltage (Can Be Used To Connect External Shunt Regulator)	I/O
5	DC-		I/O
6	L1	AC Supply Input (Single or Three Phase)	I
7	L2		I
8	L3		I

HARDWARE SETTINGS

Switch Functions

Switch	Description	Setting	
		On	Off
1	Bit 0 of binary CANopen node ID. Does not affect RS-232 settings.	1	0
2	Bit 1 of binary CANopen node ID. Does not affect RS-232 settings.	1	0
3	Bit 2 of binary CANopen node ID. Does not affect RS-232 settings.	1	0
4	Bit 3 of binary CANopen node ID. Does not affect RS-232 settings.	1	0
5	Bit 4 of binary CANopen node ID. Does not affect RS-232 settings.	1	0
6	Bit 5 of binary CANopen node ID. Does not affect RS-232 settings.	1	0
7	Bit 0 of drive CANopen bit rate setting. Does not affect RS-232 settings.	1	0
8	Bit 1 of drive CANopen bit rate setting. Does not affect RS-232 settings.	1	0

Additional Details

The drive can be configured to use the address and/or bit rate stored in non-volatile memory by setting the address and/or bit rate value to 0. Use the table below to map actual bit rates to a bit rate setting.

Bit Rate (kbits/sec)	Value For Bit Rate Setting
Load from non-volatile memory	0
500	1
250	2
125	3

Jumper Settings

Jumper	Description	Configuration		
		Not Installed	Pins 1-2	Pins 2-3
J1	CAN bus termination. Install this jumper (2.54mm) on the last drive in a CAN network. This jumper is located on a 4-pin header adjacent to the RS-232 connector. It consists of the two pins furthest from the connector.	Non-terminating Node	Terminating Node	N/A
J2	Reserved.	-	-	N/A

MECHANICAL INFORMATION

+24V LOGIC - Logic Power Connector

Connector Information	2-port, 5.08 mm spaced, enclosed, friction lock header with threaded flange	
Mating Connector	Details	Phoenix Contact: P/N 1777808
	Included with Drive	Yes

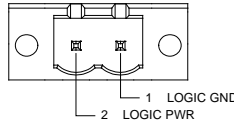

AUX COMM - RS232 Communication Connector

Connector Information	3-pin, 2.5 mm spaced, enclosed, friction lock header	
Mating Connector	Details	Phoenix: Plug P/N 1881338
	Included with Drive	Yes

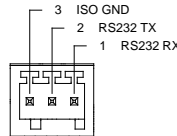

AUX ENCODER - Auxiliary Feedback Connector

Connector Information	15-pin, high-density, male D-sub	
Mating Connector	Details	TYCO: Plug P/N 1658681-1; Housing P/N 5748677-1; Terminals P/N 1658686-2 (loose) or 1658686-1 (strip)
	Included with Drive	No

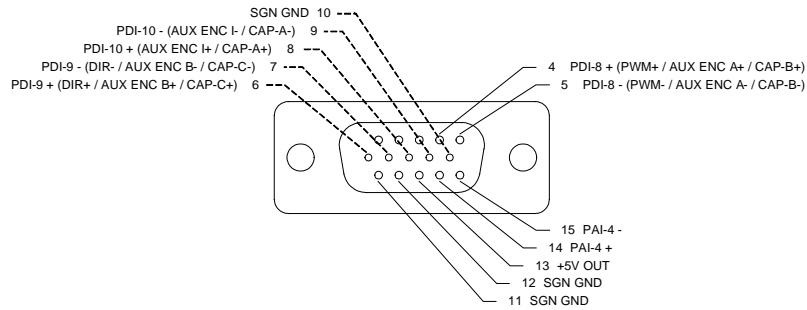

COMM - CAN Communication Connector

Connector Information		Shielded, dual RJ-45 socket with LEDs
Mating Connector	Details	AMP: Plug P/N 5-569552-3
	Included with Drive	No

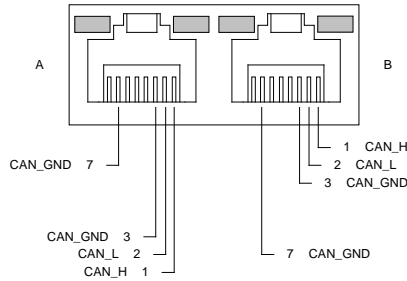

FEEDBACK - Feedback Connector

Connector Information		15-pin, high-density, female D-sub
Mating Connector	Details	TYCO: Plug P/N 748364-1; Housing P/N 5748677-1; Terminals P/N 1658670-2 (loose) or 1658670-1 (strip)
	Included with Drive	No

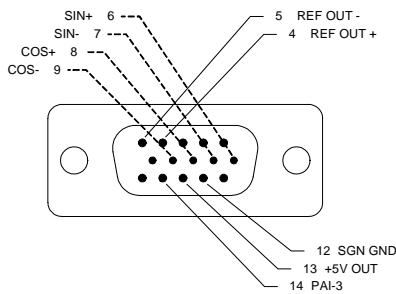

I/O - Signal Connector

Connector Information		26-pin, high-density, female D-sub
Mating Connector	Details	TYCO: Plug P/N 1658671-1; Housing P/N 5748677-2; Terminals P/N 1658670-2 (loose) or 1658670-1 (strip)
	Included with Drive	No

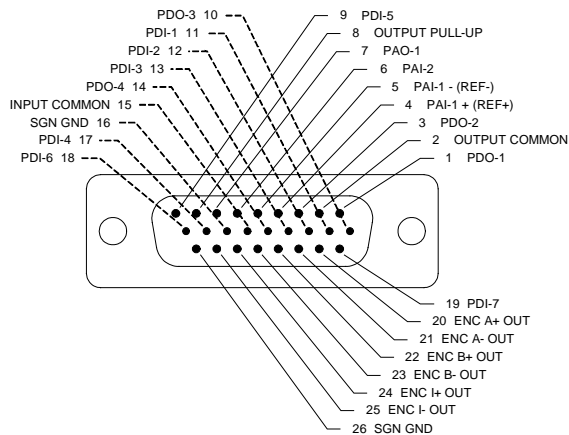

POWER - Power Connector

Connector Information		8-port, 7.62 mm spaced, enclosed, friction lock header
Mating Connector	Details	Phoenix Contact: P/N 1767067
	Included with Drive	Yes

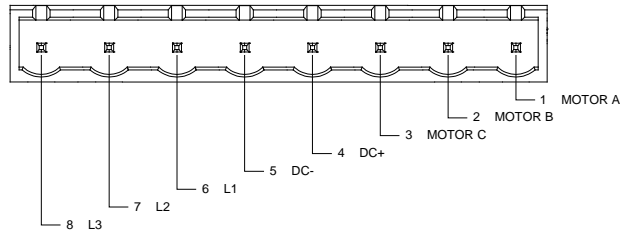

MOUNTING DIMENSIONS

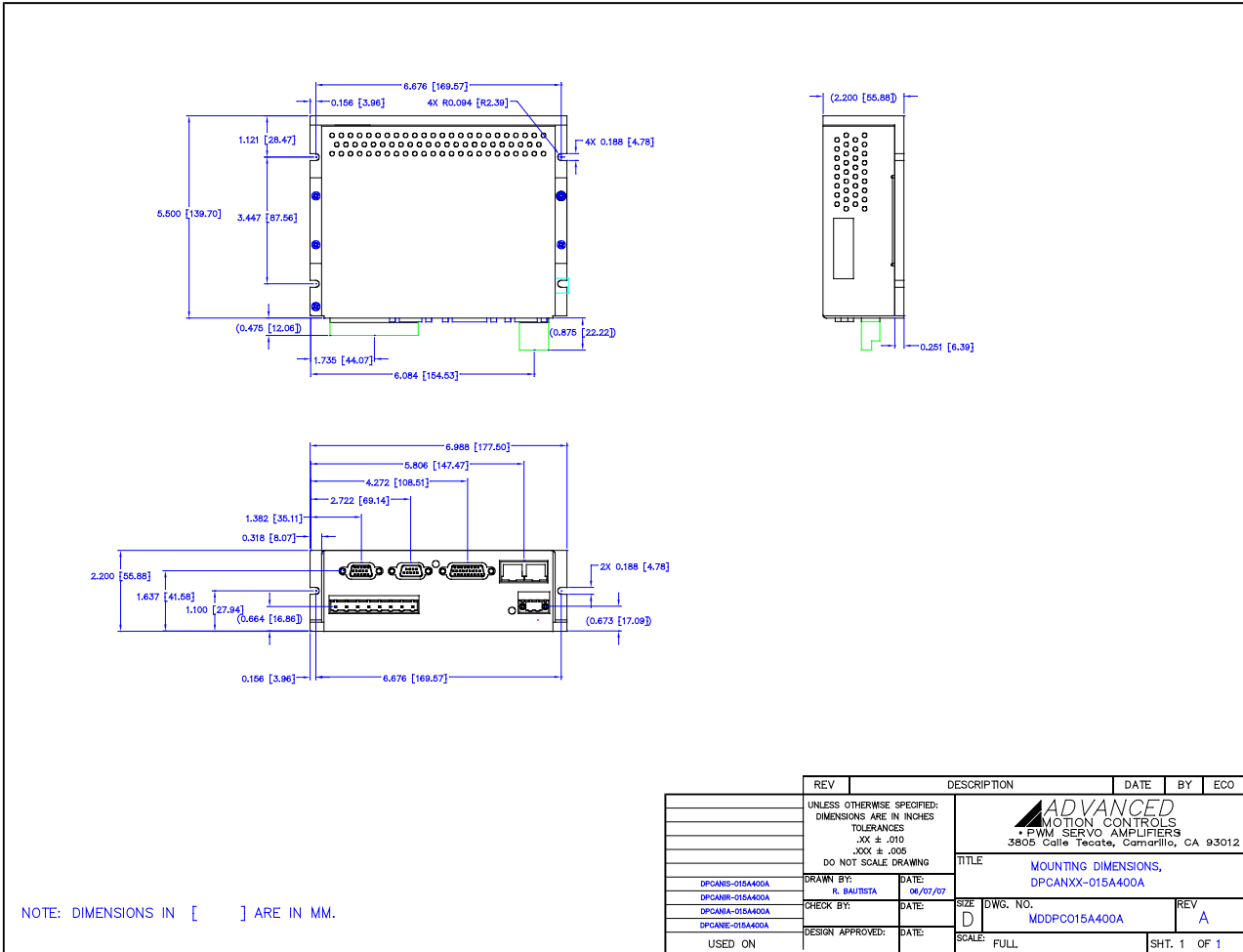

REV	DESCRIPTION	DATE	BY	ECO
	UNLESS OTHERWISE SPECIFIED: DIMENSIONS ARE IN INCHES TOLERANCES .XX ± .010 .XXX ± .005 DO NOT SCALE DRAWING			
		 ADVANCED MOTION CONTROLS • PWM SERVO AMPLIFIERS 3805 Calle Tecate, Camarillo, CA 93012		
		TITLE MOUNTING DIMENSIONS, DPCANXX-015A400A		
DPCANS-015A400A	DRAWN BY: R. BAUTISTA	DATE: 06/07/07	SIZE: D	DWG. NO. MDDPC015A400A
DPCANIR-015A400A	CHECK BY:	DATE:	SCALE: FULL	REV A
DPCANA-015A400A	DESIGN APPROVED:	DATE:		SHT. 1 OF 1
DPCANE-015A400A	USED ON			

PART NUMBERING INFORMATION

Example: **D P C A N I R - 0 1 5 A 4 0 0 -**

Drive Series

DP	DigiFlex Performance
----	----------------------

Communication

R	RS232/RS485
C	CANopen or RS232
E	EtherCAT
P	Ethernet Powerlink or TCP/IP

Command Inputs

AN	Analog (±10V) No Step & Direction
AL	Analog (±10V) Low Voltage Step & Direction (5V)
AH	Analog (±10V) High Voltage Step & Direction (24V)
NL	No Analog Low Voltage Step & Direction (5V)
NN	No Analog, No Step & Direction (Communication Interface Only)

Digital I/O

I	Isolated (24V)
T	TTL (5V) Non-Isolated

Motor Feedback

E	Incremental Encoder and/or Halls
R	Resolver
A	Absolute Sin/Cos (HiPercase & Endat)
S	Sin/Cos with Halls
U	Universal (Halls, Inc. Enc., Abs. Enc., 1Vp-p Sin/Cos Enc.)

Customer Special

Code used to identify customer specials

Max DC Bus Voltage (V_{DC})

080	80
200	200
400	400
800	800

Power and Logic Supply

A	AC Input +24V _{DC} User Logic Supply Required
S	AC Input Single Phase Only +24V _{DC} User Logic Supply Required
B	DC Input Both Logic Supply Options (Internal or User)
L	DC Input Logic Supply Required

Peak Current (A₀ to Peak)

015	15
016	16
020	20
025	25
030	30
040	40
060	60
060	60
C060	60
C100	100

DigiFlex® Performance™ series of products are available in many configurations. Note that not all possible part number combinations are offered as standard drives. All models listed in the selection tables of the website are readily available, standard product offerings.

ADVANCED Motion Controls also has the capability to promptly develop and deliver specified products for OEMs with volume requests. Our Applications and Engineering Departments will work closely with your design team through all stages of development in order to provide the best servo drive solution for your system. Equipped with on-site manufacturing for quick-turn customs capabilities, ADVANCED Motion Controls utilizes our years of engineering and manufacturing expertise to decrease your costs and time-to-market while increasing system quality and reliability. Feel free to contact Applications Engineering for further information and details.

Examples of Customized Products

- ▲ Optimized Footprint
- ▲ Private Label Software
- ▲ OEM Specified Connectors
- ▲ No Outer Case
- ▲ Increased Current Resolution
- ▲ Increased Temperature Range
- ▲ Custom Control Interface
- ▲ Integrated System I/O
- ▲ Tailored Project File
- ▲ Silkscreen Branding
- ▲ Optimized Base Plate
- ▲ Increased Current Limits
- ▲ Increased Voltage Range
- ▲ Conformal Coating
- ▲ Multi-Axis Configurations
- ▲ Reduced Profile Size and Weight

Available Accessories

ADVANCED Motion Controls offers a variety of accessories designed to facilitate drive integration into a servo system. Visit www.a-m-c.com to see which accessories will assist with your application design and implementation.



➔
To Motor